

## PT-10 10 mm Carbon Potentiometer

### FEATURES

- Carbon resistive element
- Dust proof enclosure
- Polyester substrate
- Also upon request:
  - Wiper positioned at 50% or fully clockwise.
  - Supplied in magazines for automatic insertion.
  - Long life model for low cost control potentiometer applications
  - Self extinguishable plastic UL 94V-0
  - Cut track option
  - Special tapers
  - Mechanical detents
  - Low & extra low torque versions
  - Special switch option

### MECHANICAL SPECIFICATIONS

- Mechanical rotation angle:  $235^\circ \pm 5^\circ$
- Electrical rotation angle:  $220^\circ \pm 20^\circ$
- Torque: 0.4 to 2 Ncm. (0.6 to 2.7 in-oz)
- Stop torque: > 5 Ncm. (>7 in-oz)
- Life\*: Up to 10.000 cycles

\* Others upon request

### ELECTRICAL SPECIFICATIONS

- Range of values (\*):  $100\Omega \leq R_n \leq 5\text{ M}$  (Decad. 1.0 - 2.0 - 2.2 - 2.5 - 4.7 - 5.0)
- Tolerance (\*):  $100\Omega \leq R_n \leq 1\text{M}\Omega$  .....  $\pm 20\%$   
 $1\text{M}\Omega < R_n \leq 5\text{M}\Omega$  .....  $\pm 30\%$
- Max. Voltage: 200 VDC (lin) 100 VDC (no lin)
- Nominal Power 50°C (122°F) (see power rating curve) 0.15 W (lin) 0.07 W (no lin)
- Taper (\*) (Log. & Alog. only  $R_n \geq 1\text{K}$ ) Lin ; Log; Alog.
- Residual resistance:  $\leq 5 \cdot 10^{-3} R_n$  (2  $\Omega$  min.)
- Equivalent Noise Resistance:  $\leq 3\% R_n$  (3  $\Omega$  min.)
- Operating temperature\*\*: -25°C + 70°C (-13°F + 158°F)

(\*) Others upon request

\*\* Up to 85°C depending on application

### HOW TO ORDER

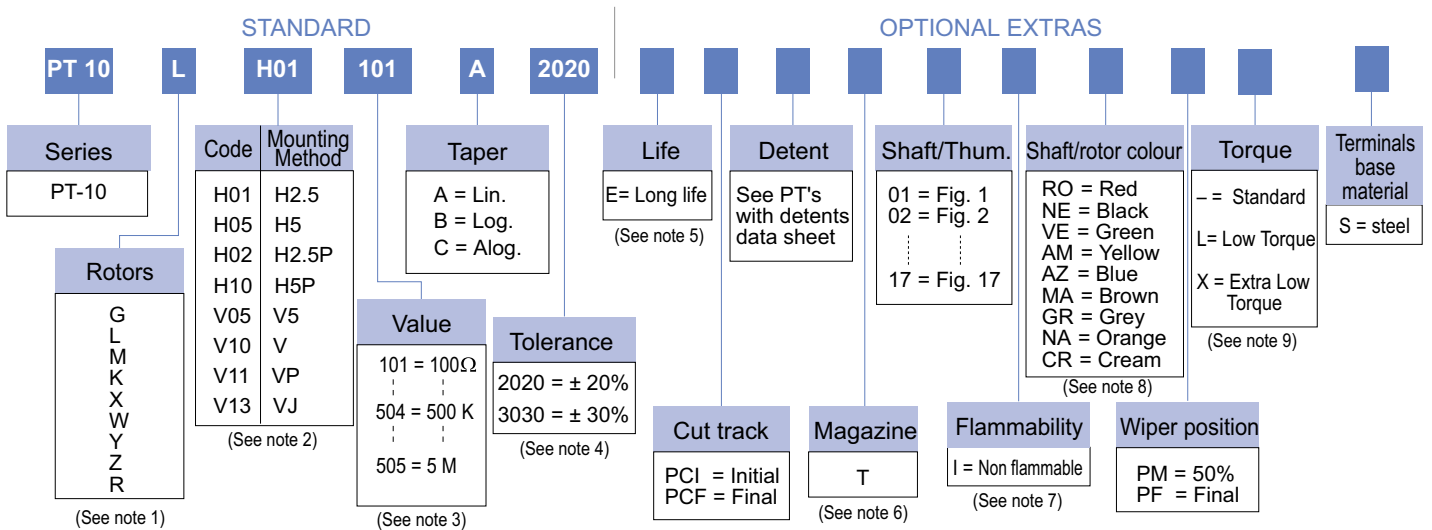

#### NOTES:

- "Z" adjustment only available on "H" versions. Rotor "G" only available in purple (shaft/rotor colour "VI").
- Terminals styles: "P" & "J" are crimped terminals. V=Vertical adjust; H=Horizontal Adjust
- Value Example: Code:  $\begin{matrix} 10 & 1 & 100 & \Omega \\ \downarrow & \downarrow & \downarrow & \\ \text{Num of zeros} & & \text{First two digits of the value.} & \end{matrix}$
- Non standard tolerance, upon request. Example:  $\begin{matrix} 07 & 05 \\ \downarrow & \downarrow \\ \text{negative tolerance} & \text{positive tolerance} \end{matrix}$
- Up to 10.000 cycles. Others upon request.
- Magazines: not available with the H10, V05 and V13 models, nor with adjustment types X, W, Y, Z.
- Non flammable: housing, rotor and shaft.
- Colour shaft/rotor:
  - Potentiometer without shaft: only rotor
  - Potentiometer with shaft: only shaft
  - Cream colour only available in standard plastic.
- Low Torque: 0.25 to 1 Ncm (per pot.)  
 Extra Low Torque: 0.1 to 0.4 Ncm (per pot.). Only available on "H" models without crimping  
 No detent option available for low and extra low torque models. No shaft or thumbwheel option for extra low torque models

NOTE: The information contained here should be used for reference purposes only.

PT-10 LH 01 + DRAWING NUMBER (Max. 16 characters)

This way of ordering should be used for options which are not included in the "How to order" standard and optional extras.

Cut track	-----	No
Detents	-----	None
Packing	-----	Bulk
Non flammable	-----	No
Rotor colour	-----	White
Shaft colour	-----	Natural
Wiper position	-----	Initial
Torque	-----	Standard
Terminals base material	-----	Brass

**ROTORS**

**Without shaft**

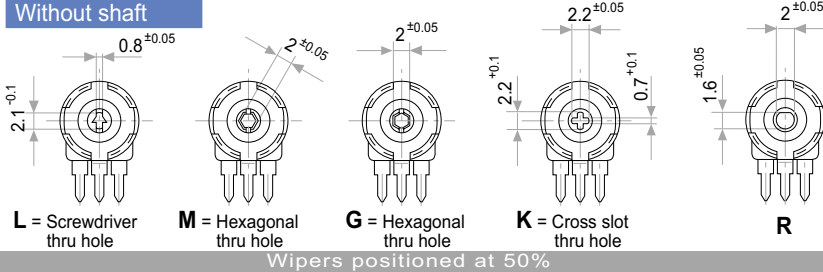

**With shaft**

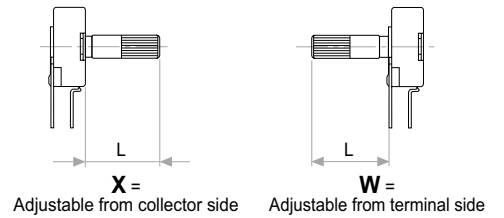

**With thumbwheel**

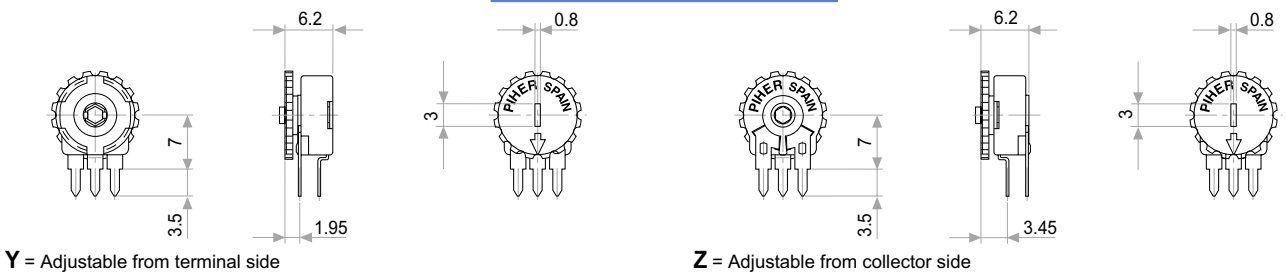

**MOUNTING METHODS**

v = horizontal mount – vertical adjust

h = vertical mount – horizontal adjust

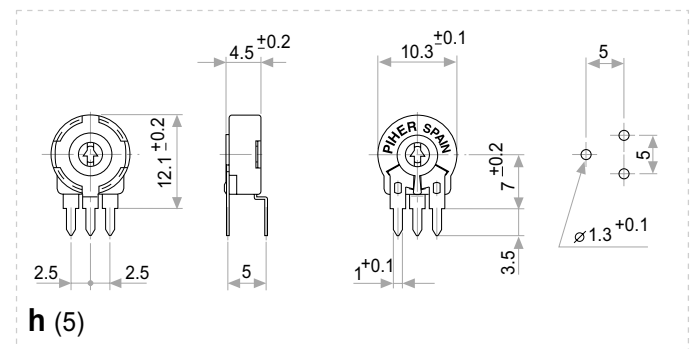
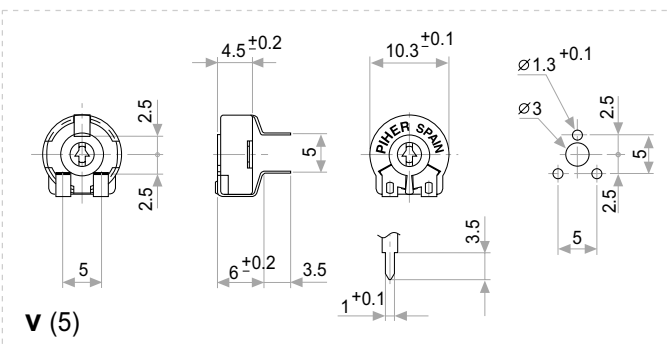
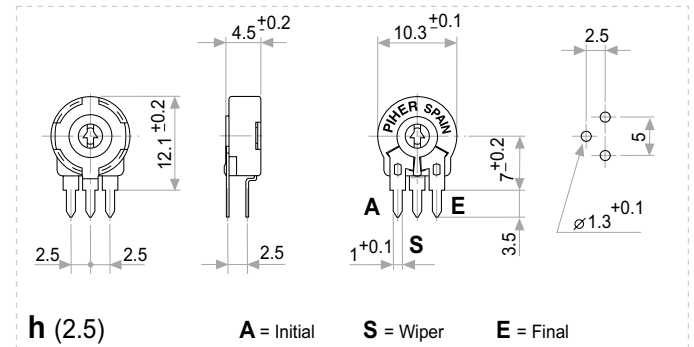
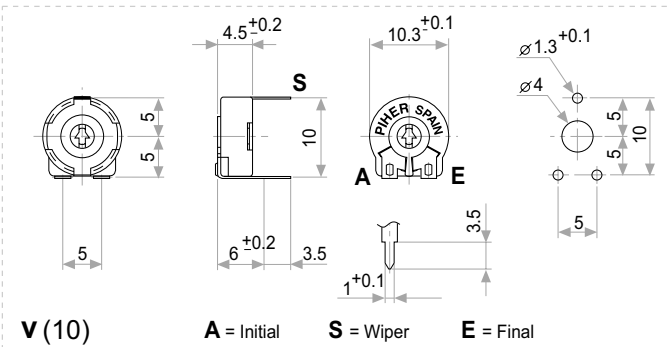

NOTE = Please note relative terminal positions when ordering non linear tapers.

**Crimped terminals**

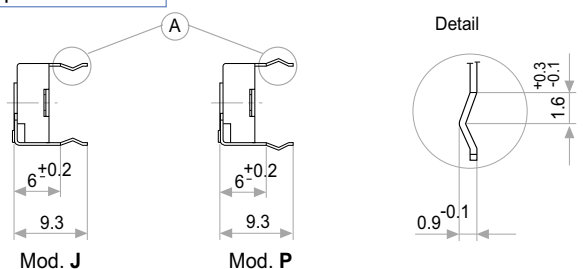

## OPTIONS

Positioning (Std. Position = CCW)

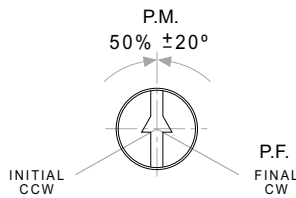

Special SWITCH (Upon request)

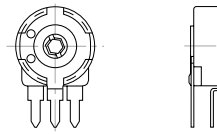

(Rotor at Final Position)

Mechanical Rotation Angle: 45°  
Housing Colour: Green

CUT TRACK  
CCW on-off (A)

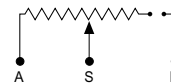
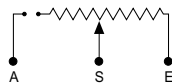

CW on-off (E)

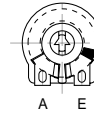

A = Initial

E = Final

S = Wiper

## TAPERS

Standard

A = Linear  
B = Log.  
C = Alog.

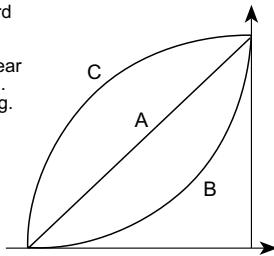

Special taper example

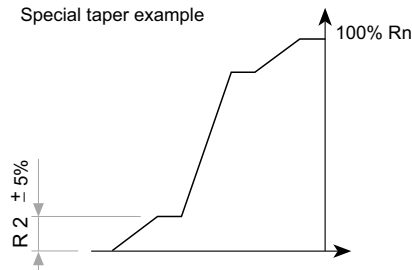

## POWER RATING CURVE

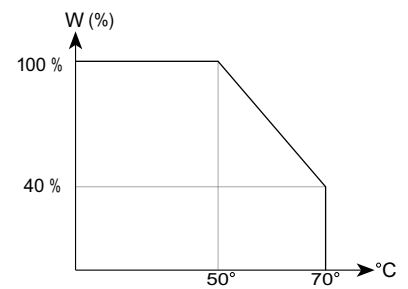

NOTE = Please note relative terminal positions when ordering non linear tapers.

## TESTS

## TYPICAL VARIATIONS

ELECTRICAL LIFE	1.000 h. @ 50°C; 0.15 W	±5 %
MECHANICAL LIFE (CYCLES)	500 @ 10 CPM ... 15 CPM	±3 % (Rn < 1 MΩ)
TEMPERATURE COEFFICIENT	-25°C; +70°C	±300 ppm (Rn < 100 K)
THERMAL CYCLING	16 h. @ 85°C; 2h. @ -25°C	±2.5 %
DAMP HEAT	500 h. @ 40°C @ 95% HR	±5 %
VIBRATION (for each plane X,Y,Z)	2 h. @ 10 Hz. ... 55 Hz.	±2 %

NOTE: Out of range values may not comply these results.

## PACKAGING

### BOXES

Model	Units
Without shaft	500 (40 x 85 x 185 mm.)
With thumbwheel	400 (40 x 85 x 185 mm.)
With shaft	200 (40 x 85 x 185 mm.)

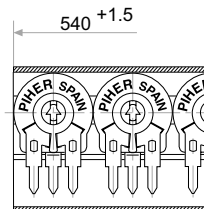
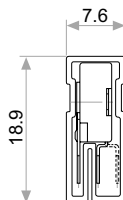

Magazines for PT-10 h 2.5; h 5

Also crimped term. h 2.5 P

### AUTOMATIC INSERTION

Magazines	Units per magazine
PT-10H & PT-10V	50 Pieces

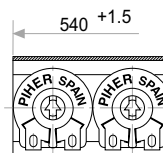
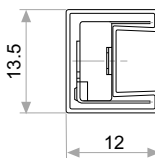

Magazines for PT-10 V

Also crimped term. VP

# SHAFTS

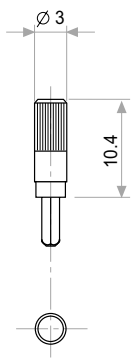

Fig. 1 / Ref. 5016

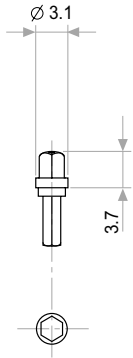

Fig. 2 / Ref. 5053

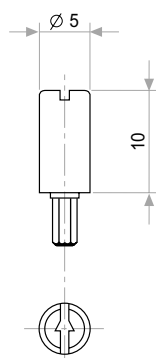

Fig. 3 / Ref. 5012

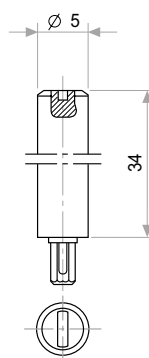

Fig. 4 / Ref. 6053

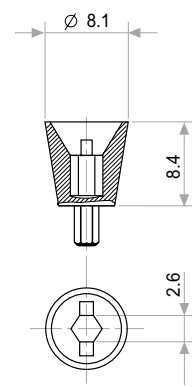

Fig. 6 / Ref. 5035

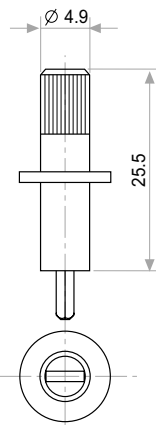

Fig. 7 / Ref. 5115

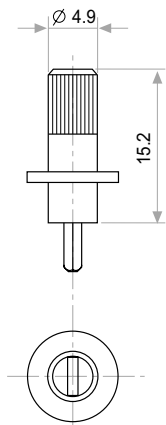

Fig. 8 / Ref. 5116

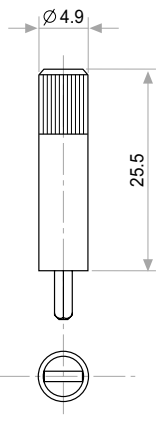

Fig. 9 / Ref. 5119

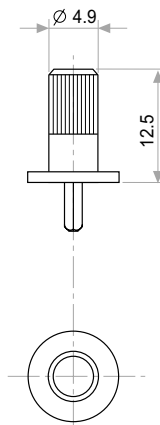

Fig. 10 / Ref. 5120

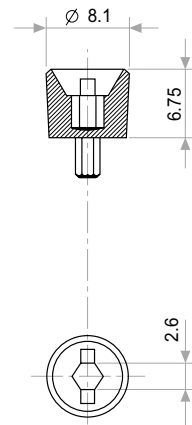

Fig. 11 / Ref. 5027

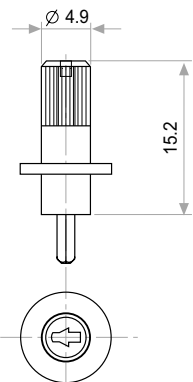

Fig. 12 / Ref. 6052

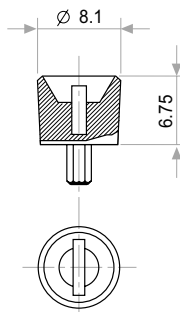

Fig. 13 / Ref. 5121

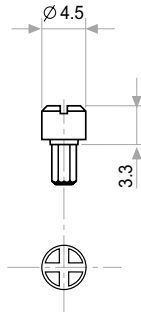

Fig. 14 / Ref. 5055

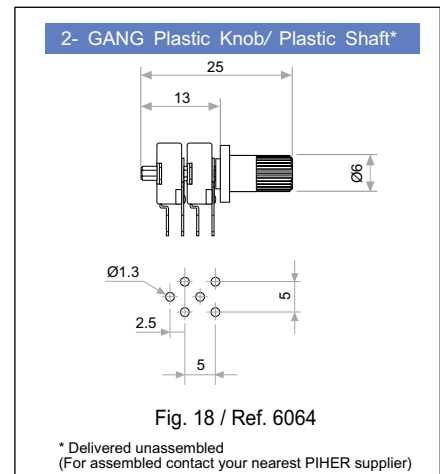

Fig. 18 / Ref. 6064

\* Delivered unassembled  
(For assembled contact your nearest PIHER supplier)

# THUMBWHEELS

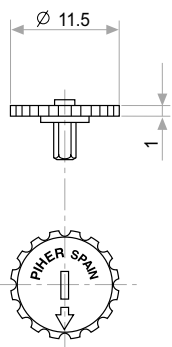

Fig. 5 / Ref. 5034

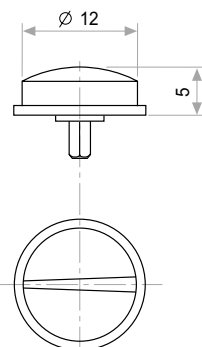

Fig. 15 / Ref. 6008

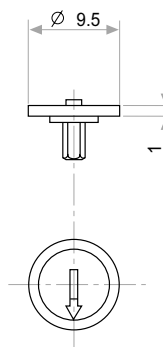

Fig. 16 / Ref. 5039

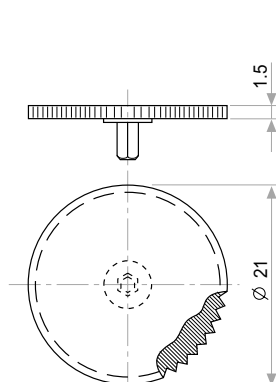

Fig. 17 / Ref. 5062